

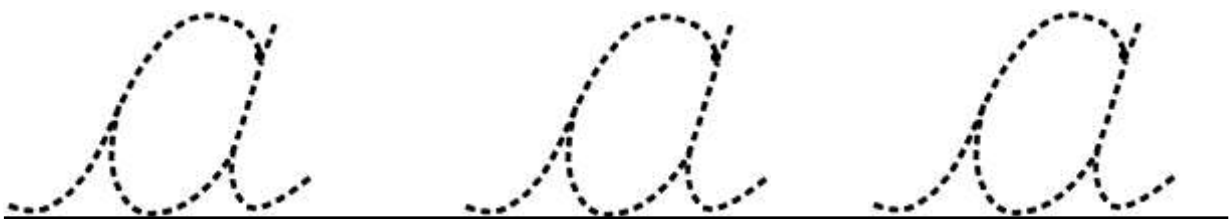

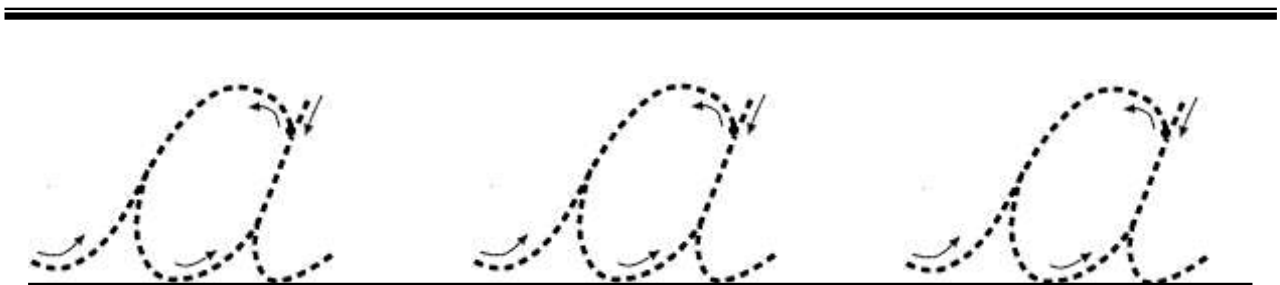

### LA VOCAL "A"

 DELINEA la "a"

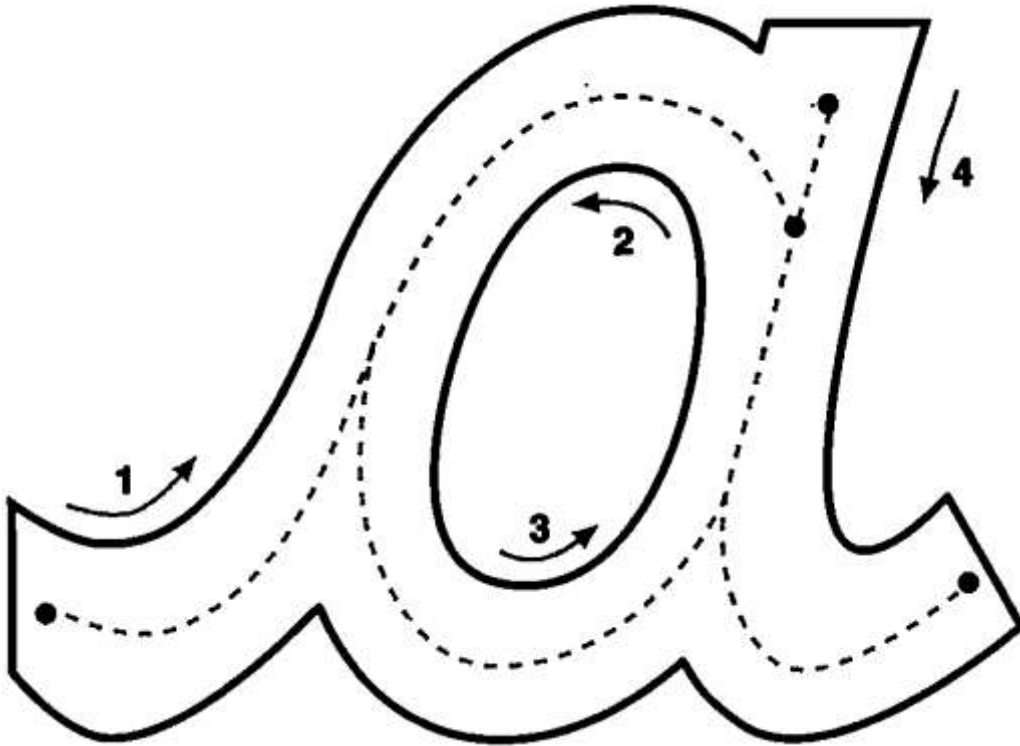

 MARCA la figura cuyo nombre empiece con "a" (Hazlo con ayuda de tu maestra)

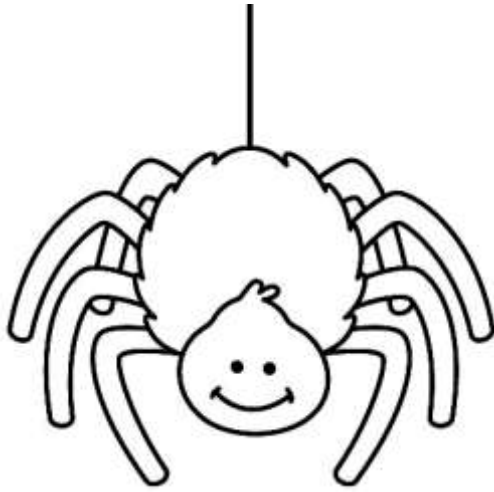

a raña

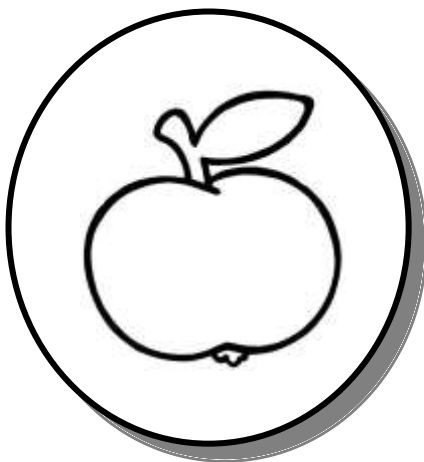
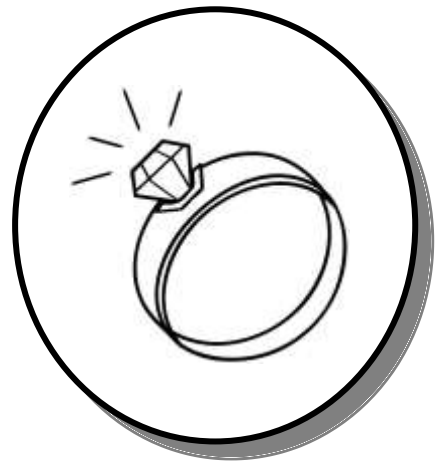
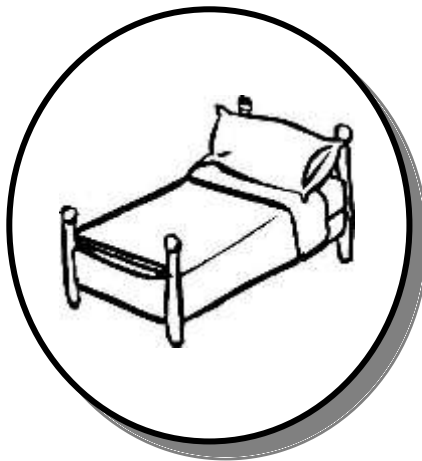

 IDENTIFICA visualmente la vocal “a” dentro de palabras escritas y  
COLORÉALAS.

Mamá

mesa

sal

Sará

Ala

mano

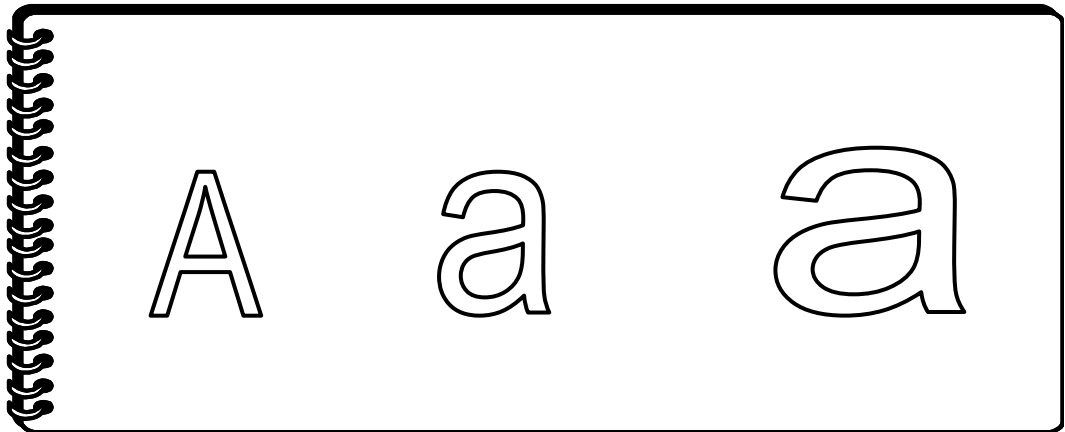

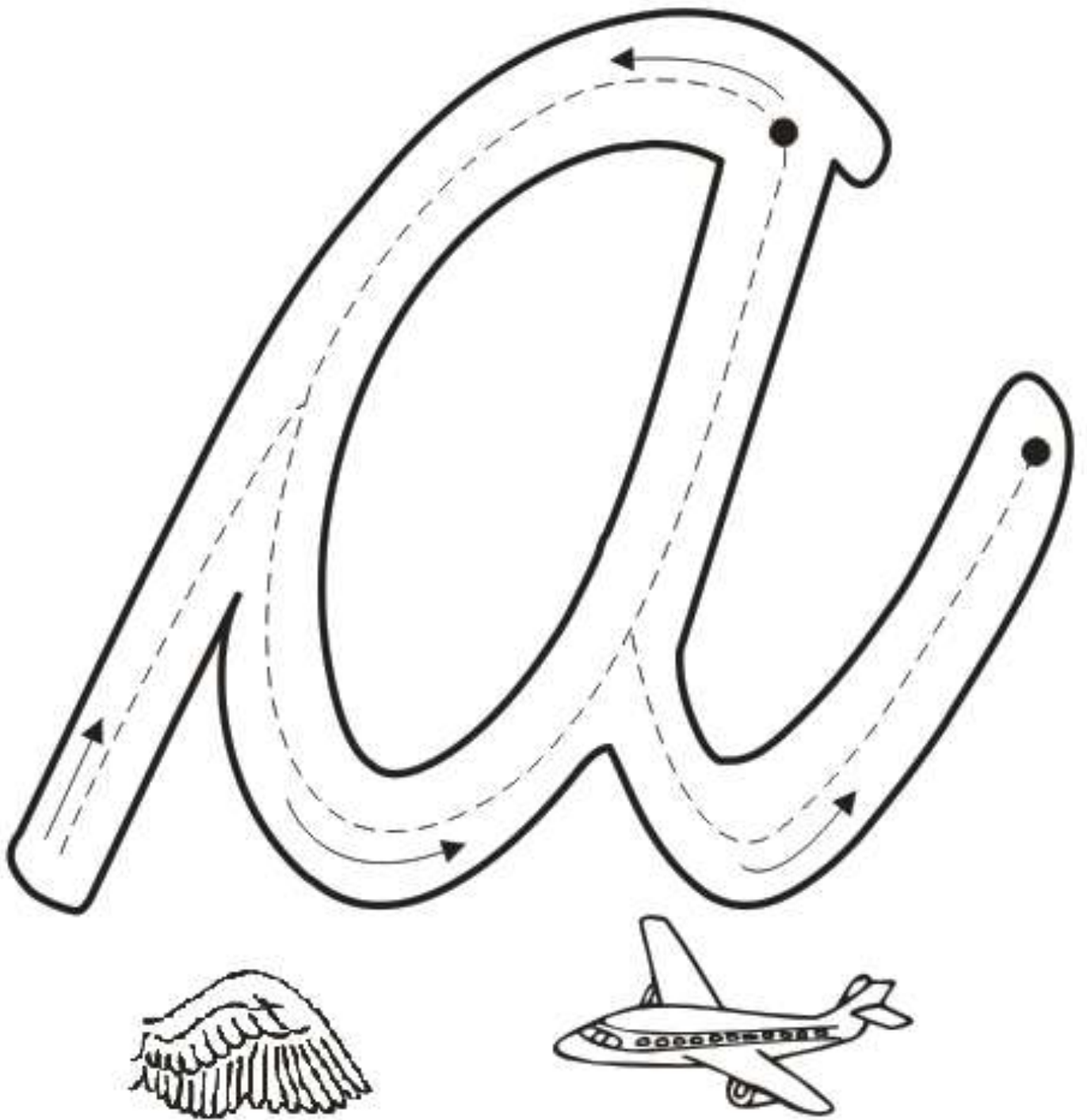

- Pega bolitas de plastelina y forma la vocal "a".
- Reconoce y colorea las figuras que empiezan con esta vocal.

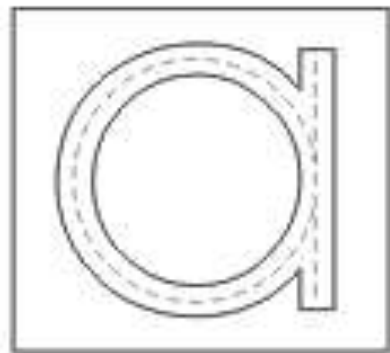
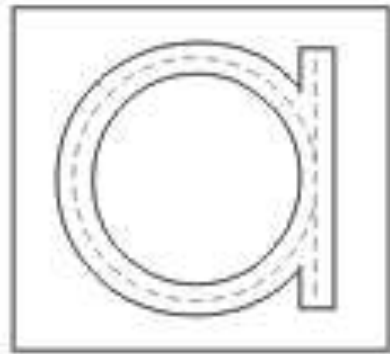
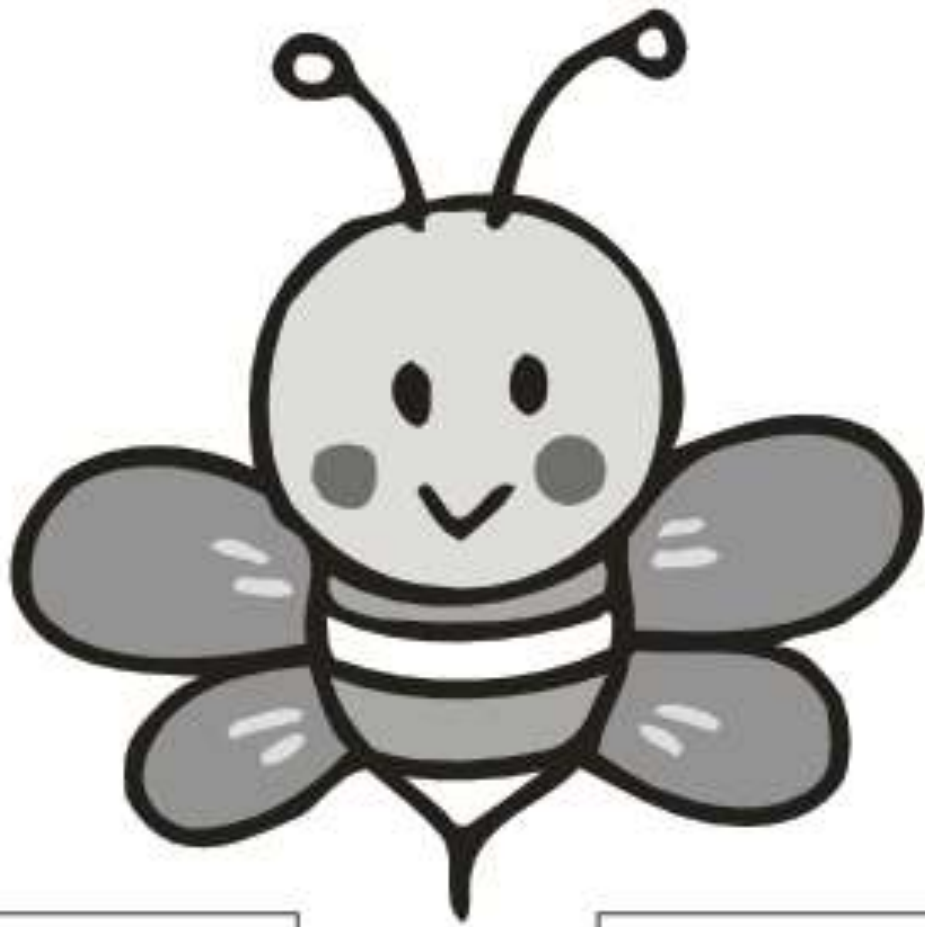

- Delinea la vocal.

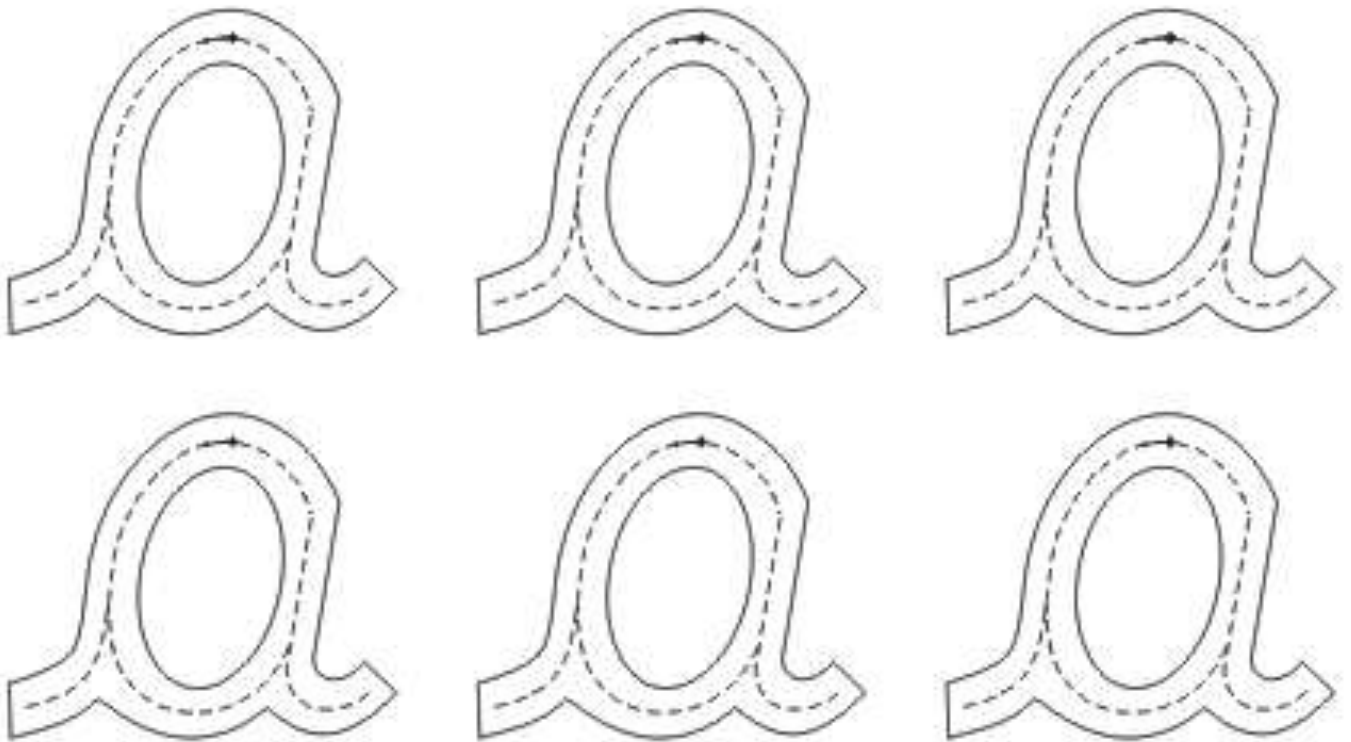
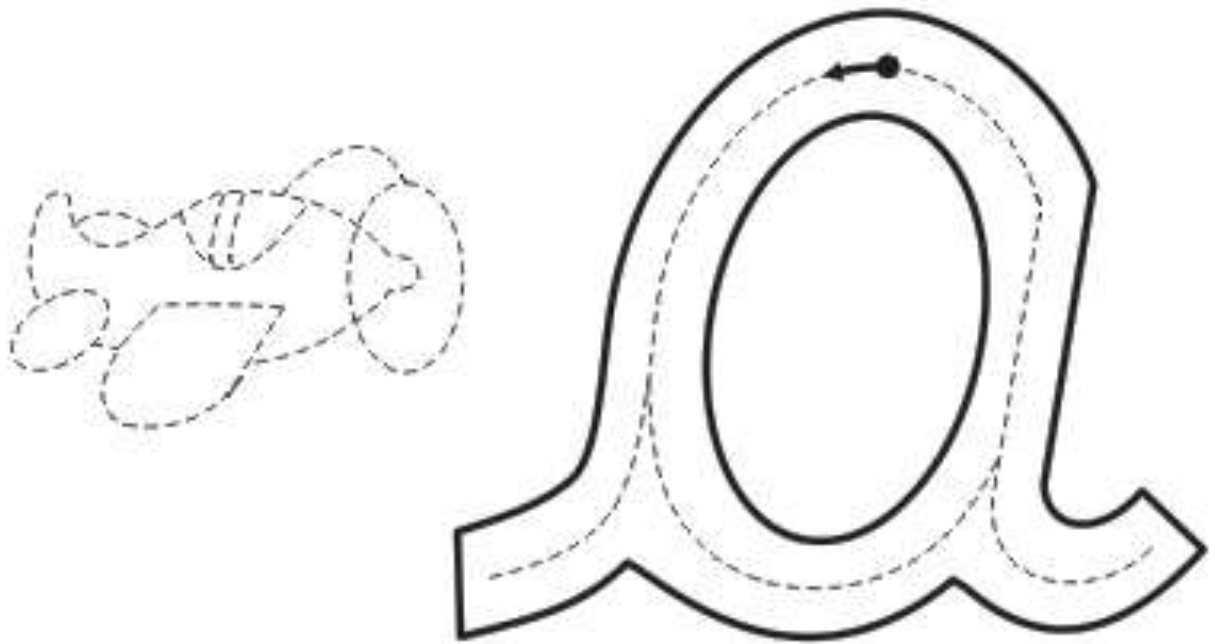

- Pega con bolitas de papel crepé en la vocal “a”
- Repasa la figura que empieza con esta vocal.
- Repasa la vocal “a” con plumón.



**Avestruz**

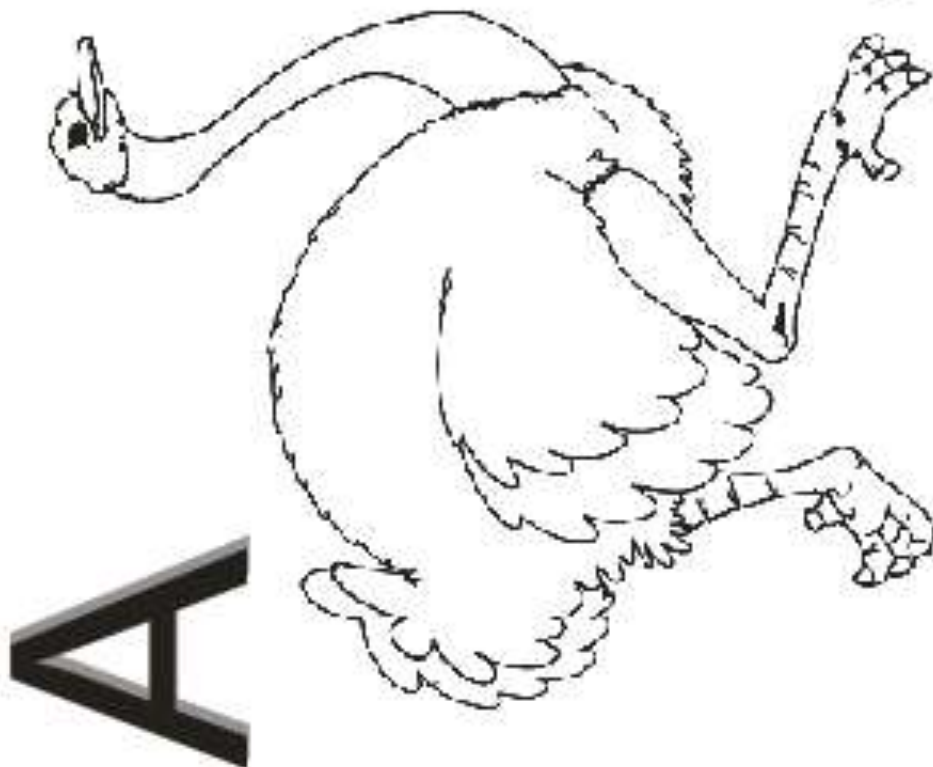
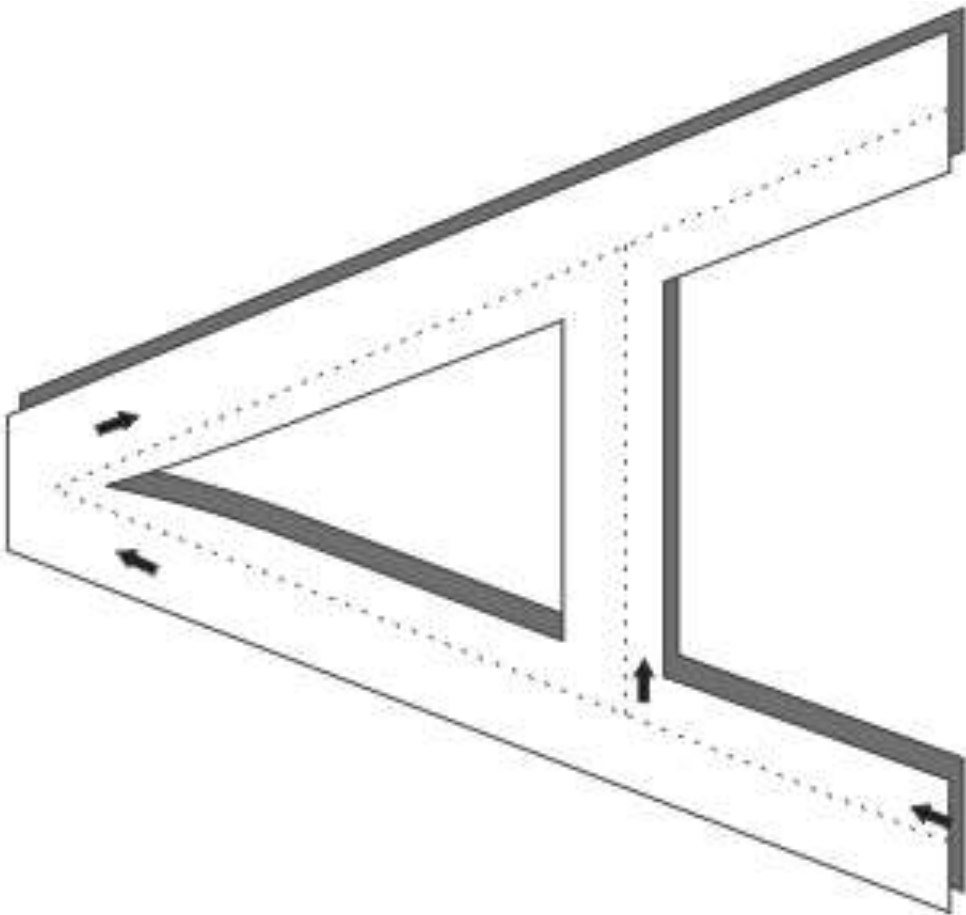

- Colorea la figura que empieza con esta vocal y repasa con plumón la vocal "A".